

The selection is detailed on page 9



SP30

Double Flanged Differential Pressure Level Transmitter

Product application

Processing engineering
Pharmaceutical industry
Food and beverage industry

Functional characteristics

High measurement accuracy The measurement range can be scaled
Multiple hazardous area application certification
Aluminum and stainless steel housing
It can be configured through the Device Type Manager and by following the field Device tool)
Can be equipped with special capillary and flange remote transmission
Digital display, field adjustable

Product description

The SP30 differential pressure transmitter is available in intrinsically safe and flameproof (ATEX standard) models, supporting 4... 20mA or 4... 20mA HART, PROFIBUS. The PA or FOUNDATION Fieldbus™ output signals to meet the application requirements. All electronic components of both transmitters (even the flameproof type) are inherently safe. Therefore, when the instrument is in the working state, it can be adjusted in the EX zone

Widely used

The SP30 is suitable for many industrial measurement applications, such as flow measurement with differential pressure sensors, level measurement or filter and pump monitoring. With diaphragm seals installed, the SP30 is also suitable for harsh process conditions. The meter is available in a measurement range from 0... 1kPa to 0... With 4MPa and a static pressure limit of 16MPa, the meter is suitable for almost all applications. The combination of internal digital signal processing and proven sensors ensures high accuracy and optimal long-term stability.

The housing is mainly available in plastic, aluminum and stainless steel to suit different operating environments, and for the food industry and pharmaceutical industry with high application requirements, electropolished stainless steel (316L) housing is also available.

Easy to configure and operate

The meter can be configured and maintained by the user through a display with an operation module (optional), where the display module can be installed in four different locations. The operation menu is well-structured, easy to understand and available in a variety of languages. In addition, the user can also use the configuration software to set the operating parameters. The instrument-specific DTM makes it easy to integrate the instrument into the corresponding decentralized control system.



Working principle

A capacitor is composed of a measuring diaphragm and electrodes on two insulating sheets. When the pressure on both sides is inconsistent, resulting in displacement of the measuring diaphragm, this line detects the digital signal superimposed on the 4-20mA signal and transmits the required information through the loop. Its displacement is proportional to the pressure difference, so the capacitance on both sides is unequal, and through the oscillation and demodulation link, it is converted into a signal proportional to the pressure.

When measuring corrosive or containing crystalline particles, as well as the measurement of large viscosity, easy solidification and other media, in order to solve the problem of corrosion or blockage of the pressure pipeline, the flange of the flange type differential pressure transmitter can be directly connected with the flange on the container, and the measuring head (metal diaphragm box) as the sensitive element is connected with the measuring chamber of the transmitter through the capillary tube. The closed system composed of a capsule, a capillary tube and a measuring chamber is filled with silicone oil, which acts as a pressure transmitting medium to isolate the transmitter from the measured medium.

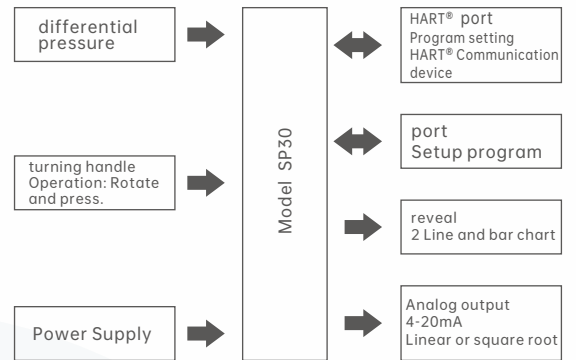

Technical parameter

specification								
Measuring range ¹⁾	MPa	0.001	0.003	0.01	0.05	0.03	1.6	4 ²⁾
Maximum working static pressure	MPa	16	16	16	16 {42}	16 {42}	16 {42}	16 {42}
Minimum range	kPa	0.025	0.03	0.1	0.5	3	16	40
Minimum static pressure ³⁾	kPa Absolute pressure	0.01						
Side overload pressure	MPa	16			16 {42}			
Lateral overload pressure	MPa	24			24 {63}			
accuracy								
Measuring range	MPa	<0.05			≥0.05			
Long-term stability	% URL/years	±0.18			±0.05			
Reference accuracy ⁴⁾	range%	The measurement range is 1.3kPa:			TD < 15:1 ±0.075%			
		TD 1:1 ±0.15% x TD			> 15:1 ±(0.0015×TD+0.053)%			
		Measuring range 10kPa:TD						
		< 4:1 ±0.075%						
		> 4:1 ±(0.012×TD+0.027)%						
Overall performance ⁵⁾⁶⁾		Plus or minus 0.15%			±0.15%			
Effects of system pressure ⁶⁾								
zero	% URL	Mpa + / - 0.35/7			±0.075/7MPa			
		Measuring range 1kPa: 0.015/0.7MPa						
range	% URL	Mpa + / - 0.14/7			±0.14/7MPa			
		Measuring range 1kPa: 0.0035/0.7MPa						
Influence of medium and ambient temperature ⁶⁾								
- Ten... + 60 °C		1kPa and 3kPa ±(0.31×TD+0.06)%			0.05MPa、0.3MPa、4MPa ±(0.08×TD+0.05)%			
					1.6MPa ±(0.1×TD+0.1)%			
		10kPa ±(0.18×TD+0.06)%			%			
- Forty... -10/+60... + 85 °C		1 kPa and 3kPa ±(0.45×TD+0.1)%			0.05MPa、0.3MPa ±(0.12×TD+0.1)%			
					1.6MPa ±(0.15×TD+0.2)%			
		10kPa ±(0.3×TD+0.15)%			4MPa ±(0.37×TD+0.1)%			
Installation position effect	kPa	0.4 or less						
Allowable temperature range								
Ambient temperature range ⁷⁾	°C	- Forty... +80 (no display) -20... +70 (with monitor)						
Transport/storage temperature range	°C	- Forty... + 80						
Process limitations depend on the sealing material ⁷⁾	°C	FKM/NBR: -20 ... + 85						
		PTFE, copper: -40... + 85						
		FKM, forbidden oil forbidden fat: -10... + 85						
For oxygen applications		Copper, PTFE: -20... +60 FKM: -10 ... + 60						
Temperature limitation	°C	Pressure difference pipeline length greater than 100mm: -40... +120 (-10...) +120, transverse flange C22.8)						

Technical parameter

Materials		
Liquid connection unit		Process connection C22.8, {316L, C276} Diaphragm: 316L, C276, {tantalum, C276 gold rhodium coating, Monel400®} Seal: FKM/FPM, NER, copper, {PTFE}
Internal transmission fluid ⁸⁾		Silicone oil
shell		Plastic (PBT; Polyester), {Aluminum}, {Stainless steel 316L}
weight	kg	About 4.2... 4.5 (depending on process connection and case version)
Electrical data		non-dangerous: 14 ... 36 Ex ia: 14 ... 30 Ex d: 20 ... 36
Power supply U _B	V DC	{FOUNDATION fieldbus™ 和 PROFIBUS® PA Ex ia: 9 ... 24 Ex d: 12 ... 32} 4 ... 20mA, 2-wire {4... 20mA 2-wire with overlapping communication signalHART®}
Output signal		{FOUNDATION Fieldbus™}、{PROFIBUS®}PA 100
Stagnant time	ms	180 (Measuring range 1, 3kPa: 250)
Time constant (63%)	ms	0 ... 999, adjustable
damping	s	$R_A = (U_B - U_{Bmin}) / 0.023A$
Maximum allowable load	R _A , 单位 Ω	
Explosion protection		
Explosion-proof ⁹⁾	ATEX	category: II 1G、II 1/2G、II 2G Ex ia IIC T6...T1 II 1/2G、II 2G Ex d ia IIC T6...T1
Environmental condition		
CE- marking		EMC 2004/108/EC for interference emission and interference resistance for industrial applications in accordance with EN 61 326-1 Interference emission Restriction Classes A and B, 94/9/EC EN 50 014 (Common) EN 50 020 (intrinsically safe), EN 50 284 (Zone 0) {EN 50 281-1 (Dust protection)}
Impact resistance	g	100, according to IEC 60 068-2-27 (Mechanical Shock)
Vibration resistance ¹⁰⁾	g	4 (5...) 100Hz (vibration under resonance)
Electrical protection class		Class III overvoltage, Class II protection IP66/67 (standard case)

{ } Items in brackets are optional and price is extra.

1) Other measuring ranges can be set by corresponding range ratio.

2) Pressure range 4 MPa, "- 'side load range up to 10 MPa.

3) Valid under standard conditions according to IEC 60 770.

4) Including non-linearity, return difference and non-repeatability after limit point setting, in accordance with IEC 60 770

5) Include -10... Nonlinearity, return difference, non-repeatability, thermal variation, zero point and static pressure effects

in the +60 °C temperature range (Pstat= 7 MPa)

6) The value is not valid for tantalum diaphragm.

7) Oxygen-20... Process temperature limit of +60 °C / Minimum temperature of PN 420: -10 °C.

8) The working pressure of halocarbon oil is higher than 0.1MPa absolute pressure.

9) You must read the operating conditions and safety related data in the approval document.

10) According to the instruction, GL characteristic line 2 is tested (not applicable to stainless steel double exterior shell).

URL = Standard measurement range

TD = range ratio



Electrical connection



Non-hazardous site

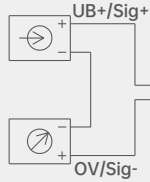

Dangerous place

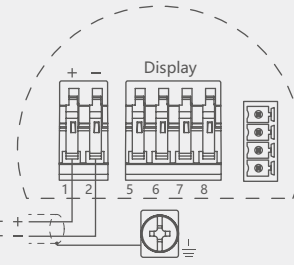

Icon symbol

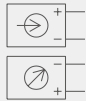

Power source

load

+ Power supply positive

- Negative terminal

} 2-wire connection



Non-hazardous site



Dangerous place

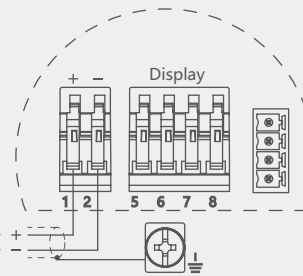

Segment coupler concentrator



Process connection

**Oval flange,
Connect 1/4-18 NPT
Or RC 1/4,
The rear end has
a drain port**

**Measuring elements
1 and 3 kPa**

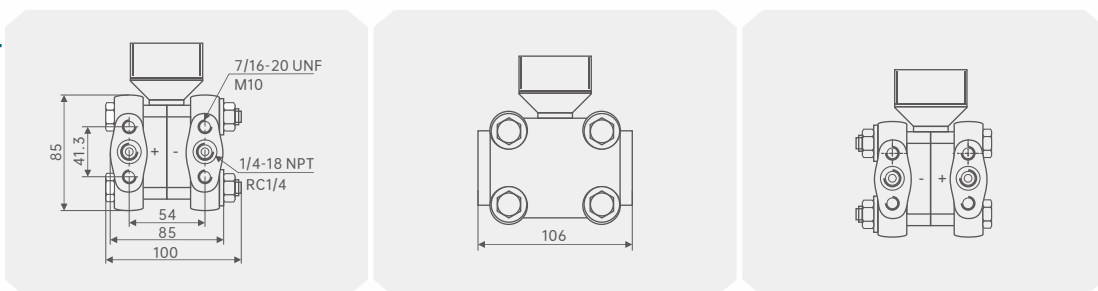

**Measuring
element 10 kPa**

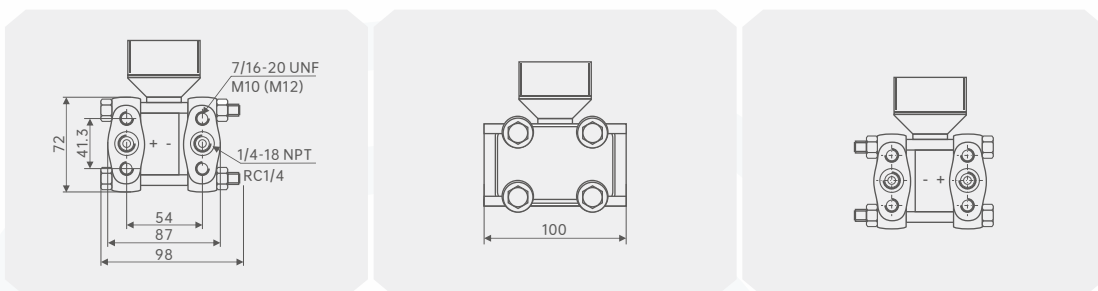

Join	Install	Materials	equipment
1/4-18 NPT IEC 61518	7/16-20UNF	Stainless steel C22.8	2One exhaust valve ¹⁾
1/4-18 NPT IEC 61518	7/16-20 UNF	AISI 316L	2 exhaust valves ¹⁾
1/4-18 NPT IEC 61518	7/16-20 UNF	C276	No valve/plug
RC 1/4	7/16-20 UNF	AISI 316L	2 exhaust valves ¹⁾
1/4-18 NPT IEC 61518	PN 160: M10; PN 420: M12	Stainless steel C22.8	2 exhaust valves ¹⁾
1/4-18 NPT IEC 61518	PN 160: M10; PN 420: M12	AISI 316L	2 exhaust valves ¹⁾
1/4-18 NPT IEC 61518	PN 160: M10; PN 420: M12	C276	No valve/plug

**Oval flange,
Connect 1/4-18 NPT
Or RC 1/4,
Lateral drain port**

**Measuring
elements 1 and 3 kPa**

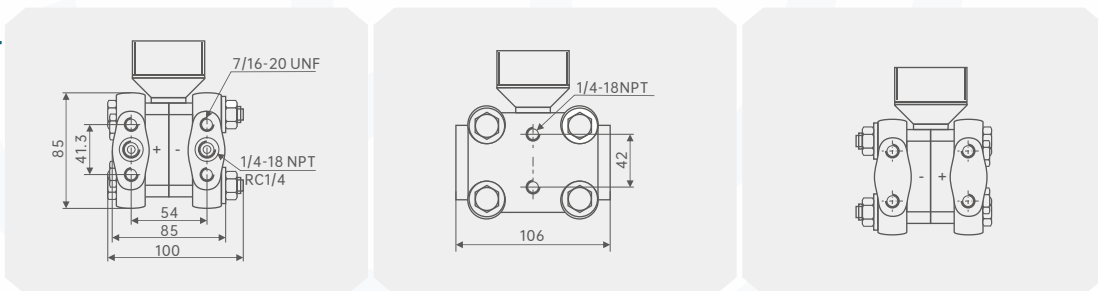

**Measuring
element ≥10 kPa**

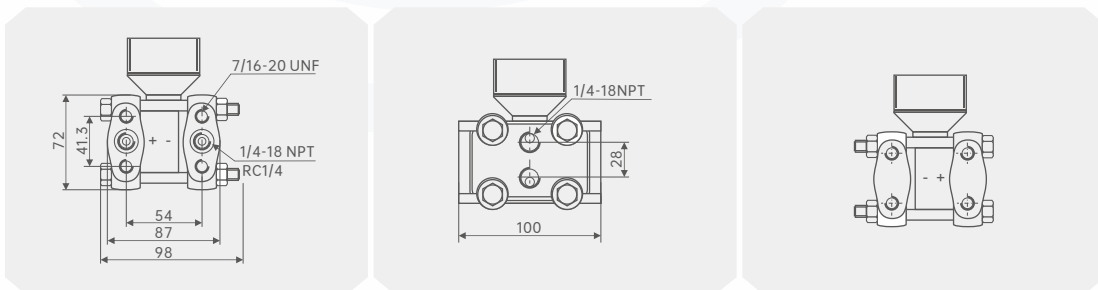

Join	Install	Materials	Equipment
1/4-18 NPT IEC 61518	7/16-20UNF	Stainless steel C22.8	21 exhaust valve, 4 plug screws ¹⁾
1/4-18 NPT IEC 61518	7/16-20 UNF	AISI 316L	2 exhaust valves, 4 plug screws ¹⁾
1/4-18 NPT IEC 61518	7/16-20 UNF	C276	No valve/plug
RC 1/4	7/16-20 UNF	AISI 316L	2 exhaust valves, 4 plug screws ¹⁾

1) 材料: AISI316L /1.4404

Shell type

Single chamber housing, plastic

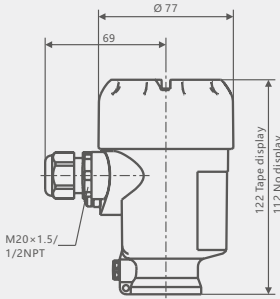

Single chamber housing, aluminum

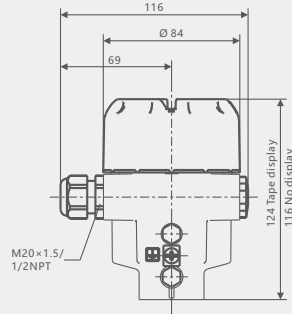

Single chamber housing, forged stainless steel

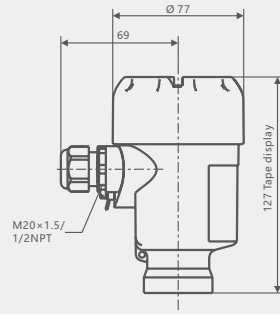

Single chamber housing, stainless steel, deep drawn

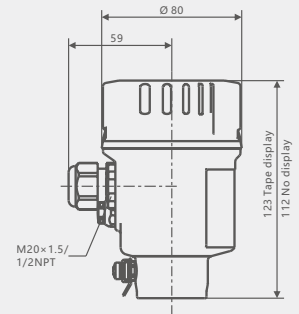

Double chamber housing, plastic

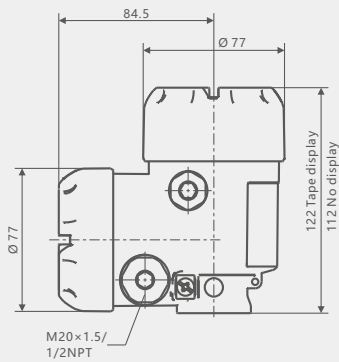

Double chamber housing, aluminum

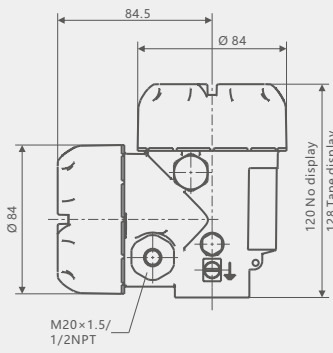

Double chamber housing, forged stainless steel

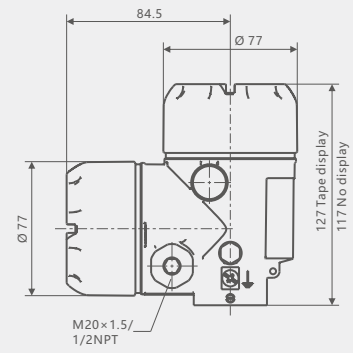

Attachment

Three way valve group

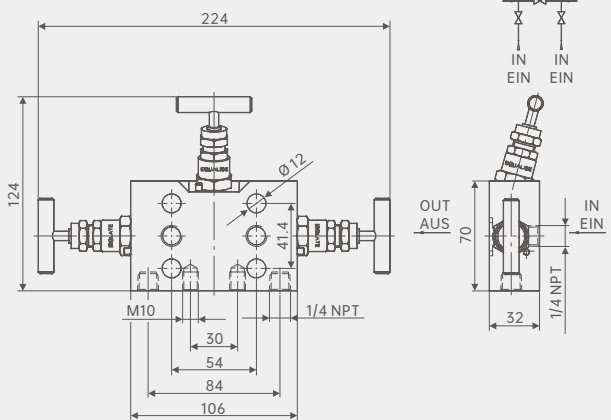

Five-way valve group

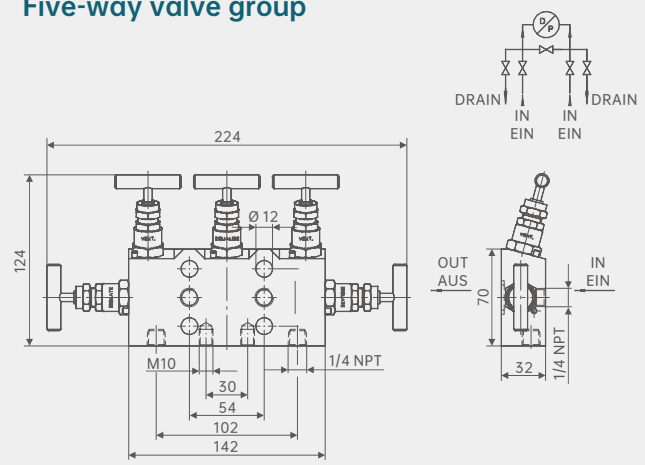

Attachment

Diaphragm seal



The SP30 differential pressure transmitter uses diaphragm or cylinder diaphragm seals and can be adapted to the most demanding conditions in the process industry. The transmitter can therefore be used under extreme temperature conditions and in conditions with aggressive, corrosive, heterogeneous, abrasive, highly viscous or toxic media. Because diaphragms can be connected in a variety of aseptic forms, such as chucks, threaded tubes or DIN 11864 aseptic joints, the measuring assembly can meet the stringent requirements of aseptic process engineering.

Differential pressure sensor



Differential pressure sensor flow measurement elements are available as accessories. Depending on the application, differential pressure sensors are designed as simple push-type plugs, measuring flanges, or complete measuring paths.

User interface

Menu language:

- German
- English
- French
- Spanish
- POLISH
- Italian
- Dutch



Display and menu item numbers

LC-Display

Operating key

DTM User interface

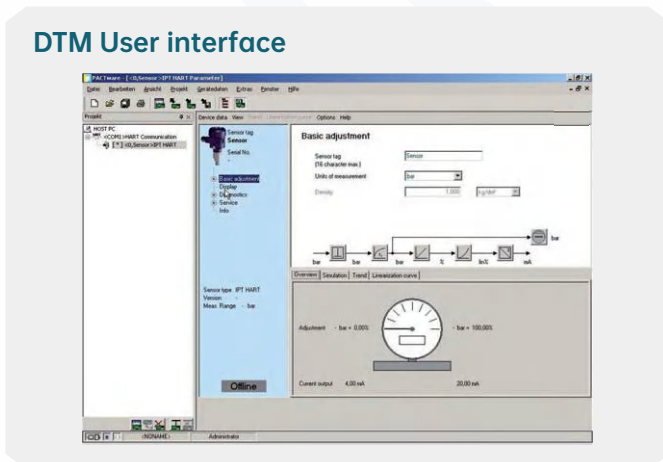





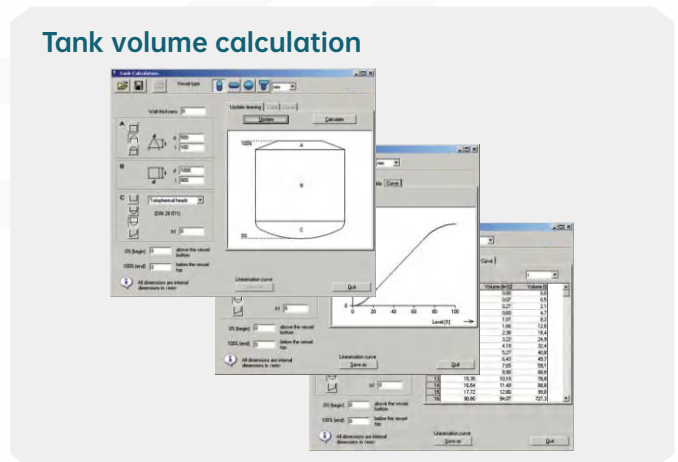





For HART output signals, Profibus-PA and FF, DTM can be used according to the FDT standard. For all transmitter setup and control procedures, DTM provides a self-parsing, clear user interface. When testing, DTM also simulates all process values and archives parameter data. Measurements can be recorded for diagnostic purposes.

Tank volume calculation



Additional tank volume calculations can be used with DTM functionality to reproduce any optional tank geometry. The corresponding linearized table is automatically generated. Linearized forms can be transferred directly to the transmitter.

Display and operation module

Model number	Functional characteristics
	Indicator module SP30, 5-digit display, 20-segment bar chart, no independent power supply, with additional HART® functions.
	Automatic adjustment of measuring range and range.
	Local host function: Available HART®
	Standard quality sets the measuring range and unit of the connected transmitter.
	Choose explosion protection according to ATEX.
	HART® modem for USB interface, designed for modern laptops
	HART® modem with RS232 interface
	Bluetooth interface [EEx ia] HART® Modem for IIC
	HART® Protocol, Li-ion Battery, Power Supply 100... 240V
	Color display with backlight, Bluetooth and infrared interface, ATEX, FM, CSA and IECEx(i) (Including FISCO, if applicable).
	HART® Protocol, NIMH Battery, Power AC 90... 240V with simple upgrade function
	ATEX II 2G (1GD) EEx ia IIC T4
	HART® protocol, universal power supply, cable with 250Ω resistor, DOF upgrade, explosion protection 
	Includes PACTware, including DTM for field equipment
	Display and operation module, aluminum housing cover, with window
	Display and operation module, cast stainless steel housing cover with window
	Display and operation module, plastic housing cover, with window
	Display and operation module, stainless steel housing cover, electrolytically polished, with window
	Three-way valve
	Chrome-nickel steel, PN 420, shape A, Nace compliant
	Five-way valve
	Oval flange 1/4 NPT chrome-nickel steel
	Chrome-nickel steel, PN 420, shape A, Nace compliant
	Oval flange 1/2 NPT chrome-nickel steel
	Chrome-nickel steel, PN 420, shape A, Nace compliant
	Wall or pipe mounting bracket, stainless steel

SP30-Selection composition

Selection example **SP30**

1	F	2	D	3	E	4	G	5	P	6	V	7	C	8	V	9	Y	10	L	11	N	12	F	13	P	14
---	---	---	---	---	---	---	---	---	---	---	---	---	---	---	---	---	---	----	---	----	---	----	---	----	---	----

1.Type of stress	G	Manometer pressure
	A	Absolute pressure
	N	Negative pressure
	D	Differential pressure
2.Measuring range	A	0 ~ 0.01... 100MPa (G-gauge pressure)
	B	0~60MPa (A- absolute pressure)
	C	-100~0kPa (n-negative pressure)
	D	-20~10MPa (D-differential pressure)
3.Display type	E	Live LED digital display
	F	On-site LCD digital display
4.Measurement accuracy	G	0.1%
	H	0.075%
	T ()	Other accuracy
5.Output signal	N	0~5V DC (Three wire)
	O	1~10C DC (Three-wire)
	P	4~20mA
	Q	4~20mA, HART protocol
	R	0-5V DC, HART protocol
	S	FF bus
	Z	Profibus
6.Electrical interface	U	1/2NPT
	V	M20*1.5
	W	G1/2
7.Process connection	A	DN25 (HG-20592 standard)
	B	DN40 (HG-20592 standard)
	C	DN50 (HG-20592 standard)
	D	DN80 (HG-20592 standard)
	E	DN100 (HG-20592 standard)
	T ()	Other connection specifications
8.Filling fluid	U	Silicone oil
	V	Fluorinert®FC-43
	T ()	Other filling fluids
9.Shell material	X	Aluminum, polyurethane coating
	Y	Stainless steel
	T ()	Other materials
10.Body material	S	304
	L	316L
	T ()	Other materials
11.Liquid material	N	316L
	O	Hastelloy C
	P	titanium
	Q	tantalum
	T ()	Other materials



SP30-Selection composition

Selection example **SP30**



12.Remote transmission (optional)	A	Double flange remote transmission (high/low pressure side - double capillary)
	B	Double flange remote transmission (high pressure flange/low pressure side - single capillary)
	E	Double flange remote transmission (high pressure flange cartridge/low pressure side - single capillary)
	F	Double flange cartridge type
	T ()	Other remote transmission
13.Mounting bracket (optional)	C	2-inch pipe mounting (stainless steel)
	D	Panel mounting bracket (stainless steel)
	T ()	Other bracket types
14.authentication	W	Intrinsically safe explosion protection
	X	flameproof
	Y	SIL certification
	Z	CE certification
	P	Non-explosion proof

Instructions:

SP30 double flanged differential pressure transmitter, the pressure type is differential pressure, the measuring range is 0~10MPa, with LED digital display, the accuracy is 0.1%, the output signal is 4-20mA, the electrical interface is M20*1.5, the process connection is DN50 flange, the filling liquid is silicone oil, the shell material is stainless steel, the body material is 316L stainless steel, and the process is used to make the differential pressure transmitter. The liquid material is 316L stainless steel, double flange cartridge type, no explosion-proof, item 13 in the table is not required.

Product Certification

Compliance and approval; Ludwig pressure gauges meet key standards and certifications for process measurement technology; Thus guaranteeing the highest reliability in such Settings;

